



BIS PIPE FITTING

I N D U S T R Y
C O M P A N Y L I M I T E D



CERTIFICATE

The TÜV CERT Certification Body
of TÜV Anlagentechnik GmbH

TÜV Rheinland Group

certifies in accordance with
TÜV CERT procedures that



BIS PIPE FITTING INDUSTRY CO., LTD.

107 Moo 4, Petchkasem Road, Omnoi,
Kratumban, Samutsakorn 74130, Thailand

has established and applies a quality management system for

Manufacturing and Sales of Pipe Fittings

An audit was performed, Report No. 006508

Proof has been furnished that the requirements according to

DIN EN ISO 9001:2000

are fulfilled.

The certificate is valid until **2006 - 12 - 31**.

Certificate Registration No. **01 100 006508**



Bangkok, 2004-03-16
First certification 2000

TÜV Rheinland
Berlin Brandenburg

TÜV CERT Certification Body of
TÜV Anlagentechnik GmbH

COMPANY PROFILE

BIS Pipe Fitting Industry Co., Ltd., founded in 1974, is one of the leading manufacturer and exporter of the High Grade Malleable Iron Pipe Fittings for use in Water, Gas, Oil and Air services. **BIS** fittings are manufactured according to the International standards, namely, the **American standard [ANSI/ASTM]**, the **British standard [BS EN]**, and the **DIN/European standard [EN]**

Our production starts with careful sourcing of raw materials and supplies. State of the Art technologies and machines are introduced into the production process. Highly strict quality controls are implemented on every step of production to ensure the product quality delivering to the market. Through years of hard work and continuing improvement of quality, we are certified and accredited with the **DIN EN ISO 9001:2000** by 'TUV' Germany for our entire quality system.

Over the years, use of **BIS** fittings proves to be the most effective and efficient, long lasting and durable, trustworthy yet economical for installation of pipelines whereas the **BIS** fittings have been widely supplied to more than 40 countries around the globe. Close and sincere cooperation with our suppliers and customers has put us on the leading edge.

The quality improvement on products and services is never ending at **BIS**. We are continuing to improve our quality fittings that value to save every single drop of water and save our earth.

Galvanized/Black Malleable Iron Pipe Fittings (Class 150) Standard specification :

Standard	AMERICAN	BRITISH	DIN
Design	ANSI/ASME B-16.3 ANSI/ASME B-16.14 ANSI/ASME B-16.39	BS EN 10242	EN 10242
Threads	ANSI/ASME B-1.20.1	BS 21	ISO7-1, ISO228-1
Material	ASTM A-197	BS 6681	EN 1562 (EN-GJMB-300-6)
Galvanizing	ASTM A-153	BS 729	DIN 2950
Type	BANDED	BANDED	BEADED



TIS 249-1997
THE NATIONAL STANDARD CERTIFICATION



Certified Management System
ISO 9001:2000



TS 11 EN 10242



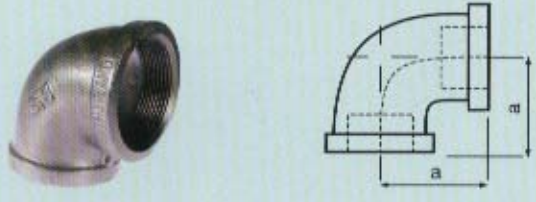
FIG. NO DESCRIPTION (ABBRE)	SIZE (INCH)	a	b (mm.)	c	PCS/ INNER	QTY OF INNER	PCS/ MASTER	WT/ MASTER KGS.
FIG. 90 (2A) ELBOWS 90° (L 90) 	1/8	17.5			50	B12	600	19
	1/4	20.6			35	B12	420	20
	3/8	24.1			45	12	540	41
	1/2	28.5			50	8	400	43
	3/4	33.3			35	6	210	33
	1	38.1			20	6	120	33
	1-1/4	44.5			20	4	80	32
	1-1/2	49.3			10	6	60	30
	2	57.2			8	4	32	28
	2-1/2	70.0			6	3	18	26
	3	81.0			7	2	14	28
	3-1/2	90.0					6	20
	4	99.0					6	21
	5	113.0					2	12
	6	132.0					2	16

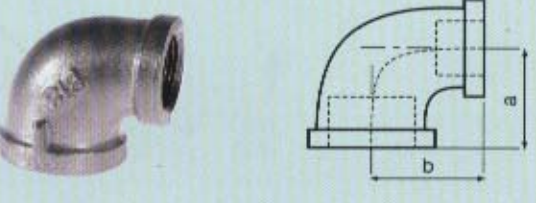
FIG. NO DESCRIPTION (ABBRE)	SIZE (INCH)	a	b (mm.)	c	PCS/ INNER	QTY OF INNER	PCS/ MASTER	WT/ MASTER KGS.
FIG. 90R (2B) RED. ELBOWS (RL) 	1/4x1/8	18.8	19.3		40	B12	480	22
	3/8x1/8	20.5	21.6		70	12	840	46
	3/8x1/4	22.4	22.9		60	12	720	47
	1/2x1/8	22.0	23.4		40	12	480	39
	1/2x1/4	24.6	24.9		40	12	480	41
	1/2x3/8	26.4	26.2		50	8	400	38
	3/4x1/8	24.1	26.0		50	8	400	44
	3/4x1/4	26.7	27.4		40	8	320	41
	3/4x3/8	28.5	28.7		25	12	300	40
	3/4x1/2	30.5	31.0		30	8	240	35
	1x1/8	26.2	29.7					
	1x1/4	28.2	31.0		40	6	240	
	1x3/8	30.0	32.3		40	6	240	43
	1x1/2	32.0	35.5		30	6	180	36
	1x3/4	34.8	36.8		25	6	150	35
	1-1/4x3/8	32.8	36.6		80	2	160	44
	1-1/4x1/2	34.0	38.9		35	4	140	40
	1-1/4x3/4	36.8	41.2		15	8	120	37
	1-1/4x1	40.1	42.4		10	8	80	28
	1-1/2x3/8	33.8	39.0		30	4	120	40
	1-1/2x1/2	35.8	42.2		25	4	100	33
	1-1/2x3/4	38.6	44.5		15	6	90	42
	1-1/2x1	41.9	45.7		10	8	80	34
	1-1/2x1-1/4	46.2	47.8		15	4	60	29
	2x1/2	37.3	43.4		15	4	60	30
	2x3/4	40.6	50.0		10	6	60	31
	2x1	43.5	50.5		14	4	56	32
	2x1-1/4	48.3	53.3		10	4	40	27
	2x1-1/2	51.3	54.9		10	4	40	29
	2-1/2x3/4	43.8	59.4		10	4	40	36
	2-1/2x1	47.5	60.2		8	4	32	31
	2-1/2x1-1/4	51.8	62.2		8	3	24	25
	2-1/2x1-1/2	54.9	63.8		8	3	24	28
	2-1/2x2	60.7	66.0		8	3	24	30
	3x1-1/2	57.9	71.0		5	4	20	29
	3x2	64.0	73.4		6	3	18	26
	3x2-1/2	71.9	75.9		8	2	16	31
	4x2	69.0	88.5				12	28
	4x2-1/2	81.0	91.0				8	24
	4x3	83.8	91.4				9	29

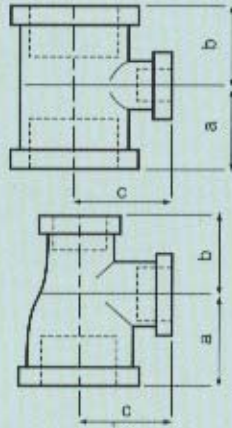


FIG. NO DESCRIPTION (ABBRE)	SIZE (INCH)	a	b (mm.)	c	PCS/ INNER	QTY OF INNER	PCS/ MASTER	WT/ MASTER KGS.	
FIG. 92 (6) STREET ELBOWS 90° (SL 90)		1/8	17.5	25.4	60	B12	720	20	
		1/4	20.6	30.2	35	B12	420	19	
		3/8	24.1	36.6	40	12	480	34	
		1/2	28.5	41.2	60	6	360	39	
		3/4	33.3	48.0	35	6	210	33	
		1	38.1	54.4	30	4	120	33	
		1-1/4	44.5	62.2	25	3	75	31	
		1-1/2	49.3	68.3	9	6	54	29	
		2	57.2	82.8	10	3	30	26	
		2-1/2	70.0	98.0	9	2	18	29	
		3	81.0	114.6	7	2	14	34	
		4	99.0	144.5			6	25	
		5	113.0	174.2					
6	132.0	204.0				2			
FIG. 120 (4) ELBOWS 45° (L 45)		1/8	17.0		50	B12	600	18	
		1/4	18.5		30	B12	360	19	
		3/8	20.3		50	12	600	42	
		1/2	22.4		50	8	400	40	
		3/4	24.9		40	6	240	38	
		1	28.5		20	6	120	31	
		1-1/4	32.8		20	4	80	30	
		1-1/2	36.3		10	6	60	30	
		2	42.7		12	3	36	26	
		2-1/2	49.5		9	3	27	36	
		3	55.1		10	2	20	33	
		4	66.3				6	19	
		5	77.5				6	23	
6	87.9				2	13			
FIG. 121 (7) STREET ELBOWS 45° (SL 45)		1/8	17.0	21.0	70	B12	840	23	
		1/4	18.5	23.9	40	B12	480	22	
		3/8	20.3	26.2	50	12	600	42	
		1/2	22.4	29.2	75	6	450	38	
		3/4	24.9	32.8	40	6	240	36	
		1	28.5	37.3	25	6	150	33	
		1-1/4	32.8	43.4	10	8	80	27	
		1-1/2	36.3	47.8	10	6	60	28	
		2	42.7	56.4	12	3	36	27	
		2-1/2	49.5	65.3	12	2	24	32	
		3	55.1	76.2	9	2	18	36	
		4	66.3	94.0			7	25	
		FIG. 130R (11B) RED. TEES (RT)		1/4x1/8	18.8	18.8	19.3	25	12
3/8x1/8	20.6			20.6	21.6	40	12	480	37
3/8x1/4	22.4			22.4	22.9	40	12	480	44
1/2x1/8	22.8			22.8	23.8	30	12	360	40
1/2x1/4	24.6			24.6	24.9	25	12	300	34
1/2x3/8	26.4			26.4	26.2	45	6	270	39
3/4x1/8	24.8			24.8	26.8	30	8	240	39
3/4x1/4	26.7			26.7	27.4	25	8	200	36
3/4x3/8	28.5			28.5	28.7	30	6	180	34
3/4x1/2	30.5			30.5	31.0	30	6	180	36
1x1/4	28.2			28.2	31.0	25	6	150	41
1x3/8	30.0			30.0	32.3	20	6	120	33
1x1/2	32.0			32.0	35.5	15	8	120	36
1x3/4	34.8			34.8	36.8	25	4	100	33
1-1/4x3/8	32.0			32.0	36.6				



FIG. NO
DESCRIPTION (ABBRE)

FIG. 130R (11B)
RED. TEES (RT)



SIZE (INCH)	a	b (mm.)	c	PCS/ INNER	QTY OF INNER	PCS/ MASTER	WT/ MASTER KGS.
1-1/4x1/2	34.0	34.0	38.9	20	4	80	34
1-1/4x3/4	36.8	36.8	41.2	12	6	72	35
1-1/4x1	40.1	40.1	42.4	16	4	64	33
1-1/2x1/4	31.0	31.0	36.0	18	4	72	33
1-1/2x1/2	35.8	35.8	42.2	18	4	72	37
1-1/2x3/4	38.6	38.6	44.5	10	6	60	31
1-1/2x1	41.9	41.9	45.7	13	4	52	34
1-1/2x1-1/4	46.2	46.2	47.8	15	3	45	33
2x1/2	37.9	37.9	47.8	10	4	40	40
2x3/4	40.6	40.6	50.0	10	4	40	31
2x1	43.9	43.9	51.3	12	3	36	30
2x1-1/4	48.3	48.3	53.3	8	4	32	28
2x1-1/2	51.3	51.3	54.9	8	4	32	31
2-1/2x1/2	41.0	41.0	57.0	8	3	24	31
2-1/2x3/4	44.2	44.2	58.9	8	3	24	30
2-1/2x1	47.5	47.5	60.2	8	3	24	34
2-1/2x1-1/4	51.8	51.8	62.2	10	2	20	29
2-1/2x1-1/2	54.9	54.9	63.8	5	3	15	23
2-1/2x2	60.7	60.7	66.0	8	2	16	28
3x1/2	43.0	43.0	65.7	6	3	18	28
3x3/4	47.5	47.5	66.3	6	3	18	27
3x1	50.8	50.8	67.6	5	3	15	25
3x1-1/4	55.1	55.1	69.6	6	2	12	21
3x1-1/2	58.2	58.2	71.1	6	2	12	21
3x2	64.0	64.0	73.4	6	2	12	25
3x2-1/2	71.9	71.9	76.0	6	2	12	29
4x1/2	50.0	50.0	79.0			10	25
4x3/4	57.0	57.0	80.5			10	27
4x1	57.0	57.0	82.5			8	22
4x1-1/4	60.5	60.5	86.5			8	24
4x1-1/2	63.8	63.8	84.3			8	24
4x2	69.6	69.6	86.6			8	28
4x2-1/2	77.5	77.5	89.2			6	23
4x3	83.8	83.8	91.4			6	24
5x3	87.0	87.0	107.0			3	17
6x2	78.2	78.2	115.8			2	15
6x2-1/2	86.1	86.1	118.4			2	16
6x3	92.5	92.5	120.7			2	16
6x4	104.9	104.9	125.5			2	18
3/4x1/2x1/2	30.5	28.5	31.0	30	6	180	35
3/4x3/8x3/4	33.3	28.7	33.3	40	4	160	35
3/4x1/2x3/4	33.3	31.0	33.3	40	4	160	35
3/4x1/2x1	34.8	33.0	34.0	35	4	140	37
1x1/2x1/2	32.0	28.5	35.5	20	6	120	28
1x1/2x3/4	34.8	31.0	36.8	20	6	120	30
1x1/2x1	38.1	35.5	38.1	15	6	90	21
1x3/4x1/2	32.0	30.5	35.3	20	6	120	32
1x3/4x3/4	34.8	33.3	36.8	25	4	100	31
1x3/4x1	38.1	36.8	38.1	15	6	90	22
1-1/4x1/2x1/2	34.0	32.0	34.4	25	4	100	33
1-1/4x1/2x3/4	48.0	42.5	53.8	25	4	100	34
1-1/4x1/2x1	40.1	34.5	42.4	20	4	80	33
1-1/4x1/2x1-1/4	44.5	38.9	44.5	10	6	60	30
1-1/4x3/4x1/2	33.8	29.3	38.3	25	4	100	32
1-1/4x3/4x3/4	36.8	33.3	41.2	10	8	80	30
1-1/4x3/4x1	40.1	36.8	42.4	10	8	80	32
1-1/4x3/4x1-1/4	44.5	41.2	44.5	10	6	60	31
1-1/4x1x1/2	34.0	32.0	38.9	18	4	72	28
1-1/4x1x3/4	36.8	34.8	41.2	18	4	72	29
1-1/4x1x1	40.1	38.1	42.4	18	4	72	34
1-1/4x1x1-1/4	44.5	42.4	44.5	10	6	60	33
1-1/2x1/2x1/2	35.0	27.4	42.3	20	4	80	31
1-1/2x1/2x3/4	38.6	31.0	44.5	20	4	80	
1-1/2x1/2x1	41.0	32.8	45.5	18	4	72	31
1-1/2x1/2x1-1/4	49.3	42.2	47.8	15	4	60	
1-1/2x1/2x1-1/2	49.3	42.2	49.3	12	4	48	33
1-1/2x3/4x1/2	35.0	29.0	42.3	20	4	80	29
1-1/2x3/4x3/4	37.9	31.9	43.3	18	4	72	31
1-1/2x3/4x1	41.9	36.9	45.7	15	4	60	34
1-1/2x3/4x1-1/4	38.0	29.5	43.5	15	4	60	35
1-1/2x3/4x1-1/2	49.3	44.5	49.3	12	4	48	32
1-1/2x1x1/2	35.0	32.3	42.3	18	4	72	30




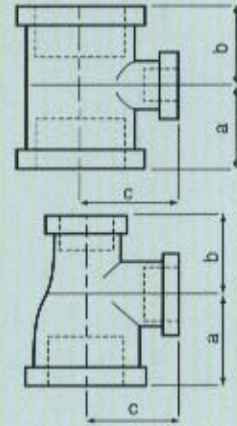

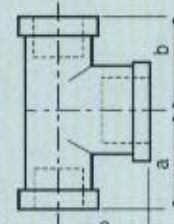

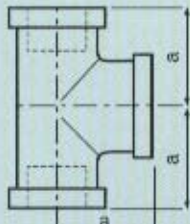
FIG. NO DESCRIPTION (ABBRE)	SIZE (INCH)	a	b (mm.)	c	PCS/ INNER	QTY OF INNER	PCS/ MASTER	WT/ MASTER KGS.
FIG. 130R (11B) RED. TEES (RT)  	1-1/2x1x3/4	41.2	33.8	49.4	15	4	60	29
	1-1/2x1x1	41.9	38.1	45.7	15	4	60	32
	1-1/2x1x1-1/4	46.2	42.4	47.8	14	4	56	36
	1-1/2x1x1-1/2	49.3	45.7	49.3	14	4	56	41
	1-1/2x1-1/4x1/2	35.8	34.0	42.2	8	8	64	30
	1-1/2x1-1/4x3/4	38.6	36.3	44.5	8	8	64	33
	1-1/2x1-1/4x1	41.9	40.1	45.7	14	4	56	33
	1-1/2x1-1/4x1-1/4	46.2	44.5	47.8	12	4	48	32
	1-1/2x1-1/4x1-1/2	49.3	47.8	49.3	10	4	40	29
	1-1/2x1-1/4x2	55.0	54.0	52.5	15	2	30	29
	2x1/2x1/2	37.8	27.0	48.7	12	4	48	27
	2x1/2x2	57.2	47.8	57.2	8	4	32	29
	2x3/4x2	57.2	50.0	57.2	8	4	32	24
	2x1x1/2	38.0	31.0	48.4	12	4	48	27
	2x1x3/4	41.2	33.0	49.0	12	4	48	27
	2x1x1	44.8	38.3	52.4	12	4	48	31
	2x1x1-1/4	47.8	42.1	54.2	10	4	40	33
	2x1x1-1/2	51.3	45.7	54.9	10	4	40	35
	2x1x2	57.2	51.3	57.2	8	4	32	33
	2x1-1/4x1/2	38.0	34.0	50.0	10	4	40	
	2x1-1/4x3/4	41.0	38.0	49.3	10	4	40	
	2x1-1/4x1	45.0	40.6	52.0	10	4	40	28
	2x1-1/4x1-1/4	48.3	44.5	53.3	6	6	36	30
	2x1-1/4x1-1/2	51.3	47.8	54.9	8	4	32	33
	2x1-1/4x2	57.2	53.3	57.2	13	2	26	27
	2x1-1/2x1/2	46.3	45.7	48.4	10	4	40	32
	2x1-1/2x1	43.9	41.9	51.3	10	4	40	30
	2x1-1/2x1-1/4	48.3	46.2	53.3	8	4	32	27
2x1-1/2x1-1/2	51.3	49.3	54.9	8	4	32	29	
2x1-1/2x2	57.2	54.8	57.2	10	3	30	27	
2-1/2x1-1/2x2-1/2	69.2	63.8	68.5			16	32	
2-1/2x2x1-1/2	60.7	57.2	63.8					
2-1/2x2x2-1/2	68.6	66.0	68.6			16	33	
3x2x2	64.0	57.2	73.4			12	23	
FIG. 130R (11B) BULL HEAD TEE (BHT)  	3/8x3/8x1/2	26.2	26.2	26.4	45	6	270	33
	1/2x1/2x3/4	31.0	31.0	30.5	30	6	180	34
	1/2x1/2x1	34.6	34.6	32.0	40	4	160	39
	3/4x3/4x1	36.8	36.8	34.8	20	6	120	33
	3/4x3/4x1-1/4	41.2	41.2	36.8	25	4	100	38
	1x1x1-1/4	42.4	42.4	40.1	15	4	60	31
	1x1x1-1/2	45.7	45.7	41.9	15	4	60	34
	1x1x2	51.3	51.3	48.9	12	4	48	
	1-1/4x1-1/4x1-1/2	47.8	47.8	46.2	14	4	56	32
	1-1/4x1-1/4x2	53.3	53.3	48.3	8	4	32	28
	1-1/2x1-1/2x2	54.9	54.9	51.3	8	4	32	31
	2x2x2-1/2	66.0	66.0	60.7	8	2	16	26
2-1/2x2-1/2x3	76.0	76.0	71.9	6	2	12	32	
FIG. 130 (11A) TEES (T)  	1/8	17.5			80	12	960	44
	1/4	20.6			50	12	600	39
	3/8	24.1			30	12	360	37
	1/2	28.5			40	6	240	35
	3/4	33.3			35	4	140	32
	1	38.1			20	4	80	30
	1-1/4	44.5			14	4	56	32
	1-1/2	49.3			15	3	45	31
	2	57.2			10	3	30	33
	2-1/2	69.0			8	2	16	35
	3	81.0			6	2	12	32
	3-1/2	90.0					6	28
	4	99.0					6	29
5	113.0					3	22	
6	132.0					2	23	




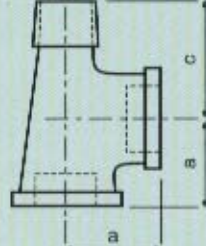

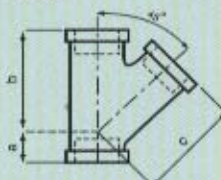

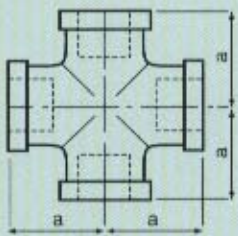

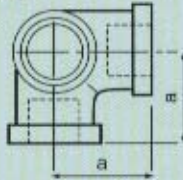

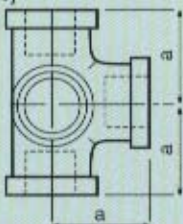
FIG. NO DESCRIPTION (ABBRE)	SIZE (INCH)	a	b (mm.)	c	PCS/ INNER	QTY OF INNER	PCS/ MASTER	WT/ MASTER KGS.
FIG. 134 (12A) STREET TEES (ST)  	1/2	28.5		41.2	40	6	240	38
	3/4	33.3		48.0	35	4	140	33
	1	38.1		54.4	20	4	80	31
	1-1/2	49.3		68.3	15	3	45	36
	2	57.2		82.8	10	3	30	41
FIG. 165 (14A) LATERAL Y BRANCH, 45° (Y 45)  	1/2	17.0	53.0	53.0	25	4	100	24
	3/4	20.0	64.0	64.0	15	4	60	21
	1	22.2	74.0	74.0	15	4	60	32
	1-1/4	30.0	89.0	89.0	18	2	36	31
	1-1/2	34.0	96.0	96.0			45	
	2	40.0	113.0	113.0				
FIG. 180 (16) CROSSES (CR)  	1/8	17.5			30	B12	360	19
	1/4	20.6			40	12	480	43
	3/8	24.1			25	12	300	39
	1/2	28.5			30	6	180	32
	3/4	33.3			20	6	120	36
	1	38.1			15	4	60	28
	1-1/4	44.5			20	2	40	29
	1-1/2	49.3			18	2	36	31
	2	57.2			10	2	20	26
	2-1/2	69.0					12	30
	3	81.0					8	24
	4	99.0					4	22
5	113.0							
6	132.0					2		
FIG. 221 (9) SIDE OUTLET ELBOWS (SOL)  	1/2	28.5			45	6	270	42
	3/4	34.0			20	8	160	38
	1	38.0			20	4	80	32
	1-1/4	44.5			15	3	45	27
	1-1/2	49.3			12	3	36	27
	2	57.0			12	2	24	31
FIG. 223 (13) SIDE OUTLET TEES (SOT)  	1/2	28.5			25	8	200	37
	3/4	34.0			15	8	120	36
	1	38.0			25	3	75	34
	1-1/4	44.5			12	3	36	26
	1-1/2	49.3			10	3	30	28
	2	57.0			10	2	20	25

FIG. NO DESCRIPTION (ABBRE)	SIZE (INCH)	a	b (mm.)	c	PCS/ INNER	QTY OF INNER	PCS/ MASTER	WT/ MASTER KGS.	
FIG. 240 (24) RED. COUPLING (RED. SOCKETS) (RS)	1/4x1/8	29.8			50	B12	600	23	
	3/8x1/8	28.7			35	B12	420	21	
	3/8x1/4	28.7			30	B12	360	19	
	1/2x1/8	31.8			50	12	600	38	
	1/2x1/4	31.8			50	12	600	44	
	1/2x3/8	31.8			40	12	480	36	
	3/4x1/8	36.6			35	12	420	45	
	3/4x1/4	36.6			30	12	360	36	
	3/4x3/8	36.6			30	12	360	42	
	3/4x1/2	36.6			60	6	360	43	
	1x1/4	42.9			45	6	270	39	
	1x3/8	42.9			30	8	240	36	
	1x1/2	42.9			30	8	240	40	
	1x3/4	42.9			25	8	200	38	
	1-1/4x3/8	52.3			30	8	240	53	
	1-1/4x1/2	52.3			25	6	150	37	
	1-1/4x3/4	52.3			25	6	150	40	
	1-1/4x1	52.3			15	8	120	34	
	1-1/2x3/8	54.0			20	6	120	28	
	1-1/2x1/2	54.0			20	6	120	55	
	1-1/2x3/4	58.7			15	8	120	41	
	1-1/2x1	58.7			25	4	100	37	
	1-1/2x1-1/4	58.7			12	8	96	36	
	2x1/4	58.0			15	6	90	35	
	2x3/8	58.0			15	6	90	39	
	2x1/2	58.0			14	6	84	37	
	2x3/4	58.0			14	6	84	38	
	2x1	71.4			28	3	84	39	
	2x1-1/4	71.4			18	4	72	35	
	2x1-1/2	71.4			24	3	72	37	
	2-1/2x1/2	65.0			20	2	40	31	
	2-1/2x3/4	65.0			20	2	40	31	
	2-1/2x1	65.0			20	2	40	29	
	2-1/2x1-1/4	65.0			20	2	40	31	
	2-1/2x1-1/2	65.0			20	2	40	30	
	2-1/2x2	65.0			20	2	40	37	
	3x1/2	75.0			16	2	32	36	
	3x3/4	75.0			16	2	32	31	
	3x1	75.0			16	2	32	30	
	3x1-1/4	75.0			16	2	32	33	
	3x1-1/2	75.0			16	2	32	33	
	3x2	75.0			16	2	32	32	
	3x2-1/2	75.0			12	2	24	30	
	4x1/2	85.0							
	4x3/4	85.0							
	4x1	85.0				6	3	18	27
	4x1-1/4	85.0				6	3	18	30
4x1-1/2	85.0				6	3	18	30	
4x2	85.0				6	3	18	30	
4x2-1/2	85.0				6	3	18	30	
4x3	85.0				6	3	18	34	
5x2	96.0								
5x3	96.0								
5x4	96.0						10	29	
6x2	104.0						8		
6x3	104.0						8		
6x4	104.0						8		
6x5	104.0						6	26	

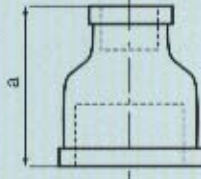
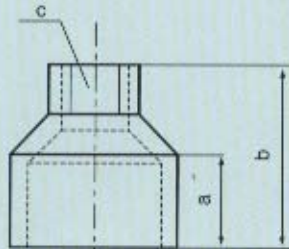
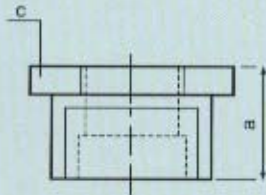




FIG. NO
DESCRIPTION (ABBRE)

FIG. 241 (35)
BUSHINGS (BU)



Note :
C : Width of Head

SIZE (INCH)	a	b (mm.)	c	PCS/ INNER	QTY OF INNER	PCS/ MASTER	WT/ MASTER KGS.
1/4x1/8	18.0		23.0	120	B12	1,440	20
3/8x1/8	19.0		26.0	75	B12	900	19
3/8x1/4	19.0		26.0	75	B12	900	17
1/2x1/8	22.0		31.0	100	12	1,200	51
1/2x1/4	22.0		31.0	100	12	1,200	47
1/2x3/8	22.0		31.0	100	12	1,200	47
3/4x1/8	24.0		33.0	50	12	600	44
3/4x1/4	24.0		33.0	50	12	600	43
3/4x3/8	24.0		33.0	50	12	600	39
3/4x1/2	24.0		33.0	50	12	600	35
1x1/8	19.2	29.8	28.5	50	8	400	48
1x1/4	19.2	29.8	28.5	50	8	400	49
1x3/8	19.2	29.8	28.5	50	8	400	49
1x1/2	29.5		40.0	50	8	400	41
1x3/4	29.5		40.0	50	8	400	34
1-1/4x1/8	20.3	32.9	28.5	30	8	240	37
1-1/4x1/4	20.3	32.9	28.5	30	8	240	61
1-1/4x3/8	20.3	32.9	28.5	30	8	240	37
1-1/4x1/2	20.3	32.9	34.0	30	8	240	48
1-1/4x3/4	26.0		45.0	30	8	240	41
1-1/4x1	28.0		45.0	30	8	240	34
1-1/2x1/4	17.2	30.2	29.7	25	6	150	38
1-1/2x3/8	17.2	30.2	29.7	25	6	150	28
1-1/2x1/2	31.0		50.0	25	6	150	42
1-1/2x3/4	21.0	35.4	41.5	25	6	150	43
1-1/2x1	30.0		55.2	25	6	150	36
1-1/2x1-1/4	30.0		55.2	25	6	150	26
2x1/4	22.5	38.0	28.5	20	6	120	43
2x3/8	22.5	38.0	28.5	20	6	120	47
2x1/2	22.5	38.0	34.0	20	6	120	50
2x3/4	22.5	38.0	41.5	20	6	120	37
2x1	22.5	38.0	49.5	20	6	120	49
2x1-1/4	35.0		63.7	20	6	120	44
2x1-1/2	35.0		63.7	20	6	120	37
2-1/2x1/2	28.0	44.2	34.0	15	4	60	44
2-1/2x3/4	28.0	44.5	42.0	15	4	60	38
2-1/2x1	28.0	38.5	50.0	15	4	60	43
2-1/2x1-1/4	38.5		75.7	15	4	60	40
2-1/2x1-1/2	38.5		75.7	15	4	60	39
2-1/2x2	36.6		75.7	15	4	60	29
3x1/2	44.0		95.0	12	4	48	48
3x3/4	44.0		95.0	12	4	48	48
3x1	44.0		95.0	12	4	48	50
3x1-1/4	44.0		95.0	12	4	48	55
3x1-1/2	44.0		95.0	12	4	48	51
3x2	44.0		95.0	12	4	48	48
3x2-1/2	44.0		95.0	12	4	48	37
3-1/2x1-1/2	30.0	43.5	68.0	8	4	32	33
3-1/2x2	30.0	43.5	84.0	8	4	32	33
3-1/2x3	41.0		117.3	8	4	32	30
4x1/2	51.0		117.3				
4x3/4	51.0		117.3				
4x1	51.0		117.3	5	4	20	36
4x1-1/4	51.0		117.3	5	4	20	38
4x1-1/2	51.0		117.3	5	4	20	32
4x2	51.0		117.3	5	4	20	33
4x2-1/2	29.4	52.7	98.3	5	4	20	34
4x3	51.0		117.3	5	4	20	31
5x4	57.0		150.0	5	2	10	23
6x2	64.0		170.0	2	4	8	34
6x2-1/2	64.0		170.0				
6x3	64.0		170.0	2	4	8	36
6x4	64.0		170.0	2	4	8	33
6x5	64.0		170.0	5	2	10	29


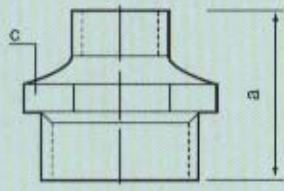

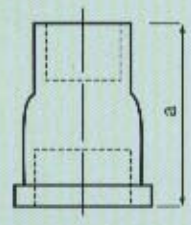

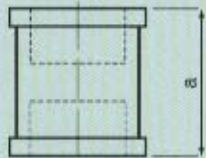

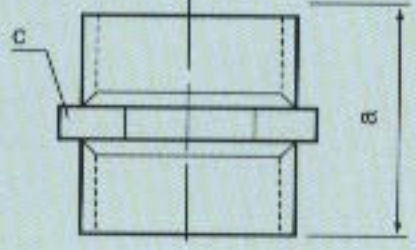
FIG. NO DESCRIPTION (ABBRE)	SIZE (INCH)	a	b (mm.)	c	PCS/ INNER	QTY OF INNER	PCS/ MASTER	WT/ MASTER KGS.	
FIG. 245 (29B) RED. HEX. NIPPLES (RNI)   Note : C : Spanner width	3/8x1/4	38.0		19.0	60	6	360	15	
	1/2x1/4	44.0		24.0	60	12	720	41	
	1/2x3/8	44.0		26.0	70	8	560	40	
	3/4x3/8	47.0		30.0	50	8	400	38	
	3/4x1/2	47.0		30.0	50	8	400	43	
	1x1/2	53.0		36.0	50	6	300	45	
	1x3/4	53.0		38.0	40	6	240	41	
	1-1/4x1/2	57.0		46.0	30	6	180	45	
	1-1/4x3/4	57.0		46.0	20	8	160	38	
	1-1/4x1	57.0		46.0	35	4	140	35	
	1-1/2x1/2	59.0		50.0	15	6	90	24	
	1-1/2x3/4	59.0		50.0	15	6	90	25	
	1-1/2x1	59.0		50.0	15	6	90	27	
	1-1/2x1-1/4	59.0		50.0	25	4	100	32	
	2x3/4	68.0		65.0					
	2x1	68.0		65.0	5	8	40	19	
	2x1-1/4	68.0		65.0	18	4	72	34	
	2x1-1/2	68.0		65.0	18	4	72	33	
	2-1/2x1-1/2	75.0		80.0	20	2	40	28	
	2-1/2x2	75.0		80.0	20	2	40	29	
3x2	83.0		94.0	12	2	24	26		
3x2-1/2	83.0		94.0	12	2	24	23		
4x2	92.0		120.0	10	2	20	37		
4x3	92.0		120.0	10	2	20	35		
FIG. NO DESCRIPTION (ABBRE)	SIZE (INCH)	a	b (mm.)	c	PCS/ INNER	QTY OF INNER	PCS/ MASTER	WT/ MASTER KGS.	
FIG. 246 (36) EXTENSION PIECES (X)  	3/8	32.0				B12	480	22	
	1/2	41.0				12	600	55	
	3/4	48.5				8	320	42	
	1	56.0				6	180	35	
	1-1/4	60.0				4	120	36	
	1-1/2	65.0				20	4	80	31
	2	71.0				15	4	60	36
	FIG. NO DESCRIPTION (ABBRE)	SIZE (INCH)	a	b (mm.)	c	PCS/ INNER	QTY OF INNER	PCS/ MASTER	WT/ MASTER KGS.
FIG. 270 (21) COUPLINGS (SOCKETS) (S)  	1/8	24.4			70	B12	840	23	
	1/4	26.9			40	B12	480	21	
	3/8	29.5			50	12	600	36	
	1/2	34.0			40	12	480	40	
	3/4	39.0			50	6	300	38	
	1	42.4			25	6	150	31	
	1-1/4	49.0			16	8	128	38	
	1-1/2	54.6			18	4	72	28	
	2	64.3			12	4	48	28	
	2-1/2	73.2			8	4	32	35	
	3	80.8			8	3	24	30	
	4	93.7			7	2	14	30	
	6	105.0					2	9	

FIG. NO DESCRIPTION (ABBRE)	SIZE (INCH)	a	b (mm.)	c	PCS/ INNER	QTY OF INNER	PCS/ MASTER	WT/ MASTER KGS.
FIG. 280 (29) HEXAGON NIPPLES (NI)  	1/8	29.0		14.0	200	12	2,400	42
	1/4	36.0		18.0	150	12	1,800	57
	3/8	38.0		22.0	80	12	960	47
	1/2	44.0		25.0	50	12	600	39
	3/4	48.0		32.0	40	8	320	39
	1	52.0		38.0	40	6	240	43
	1-1/4	57.0		46.0	20	8	160	37
	1-1/2	59.0		54.0	30	4	120	44
	2	68.0		68.0	20	3	60	30
	2-1/2	75.0		82.0	20	2	40	32
	3	83.0		94.0	12	2	24	24
	4	95.0		120.0			20	33
	5	104.0		145.0			12	36
	6	117.0		170.0			6	26

Note :
C : Spanner width


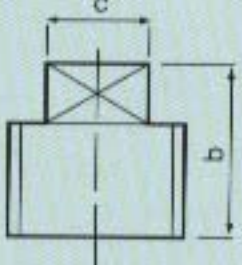
FIG. NO DESCRIPTION (ABBRE)	SIZE (INCH)	a	b (mm.)	c	PCS/ INNER	QTY OF INNER	PCS/ MASTER	WT/ MASTER KGS.
FIG. 290 (31) PLUGS (P)  	1/8		15.4	7.0	300	B12	3,600	26
	1/4		18.2	9.5	150	B12	1,800	24
	3/8		20.2	11	100	B12	1,200	31
	1/2		24.1	14.2	50	B12	600	27
	3/4		27.1	15.8	30	B12	360	25
	1		31.8	20.6	20	B12	240	23
	1-1/4		34.5	23.8	40	6	240	34
	1-1/2		36.0	26.5	30	6	180	33
	2		40.0	33.3	20	6	120	36
	2-1/2		49.0	42.0	16	4	64	40
	3		52.0	47.0	16	3	48	36
	3-1/2		54.0	49.0	16	2	32	37
	4		64.0	58.0	8	2	16	28
	5		70.0	68.5	8	2	16	38
	6		73.0	76.5			10	30


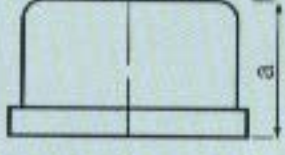
FIG. NO DESCRIPTION (ABBRE)	SIZE (INCH)	a	b (mm.)	c	PCS/ INNER	QTY OF INNER	PCS/ MASTER	WT/ MASTER KGS.
FIG. 301 (18) CAPS (CA)  	1/8	14.0			120	B12	1,440	25
	1/4	15.0			80	B12	960	26
	3/8	18.8			60	B12	720	32
	1/2	22.2			75	12	900	54
	3/4	24.6			40	12	480	44
	1	29.5			35	8	280	46
	1-1/4	32.5			25	8	200	48
	1-1/2	33.8			25	6	150	47
	2	36.8			18	6	108	44
	2-1/2	43.2			28	2	56	44
	3	45.7			21	2	42	41
	4	52.8			7	3	21	36
	5	58.9					19	45
	6	64.8					11	38



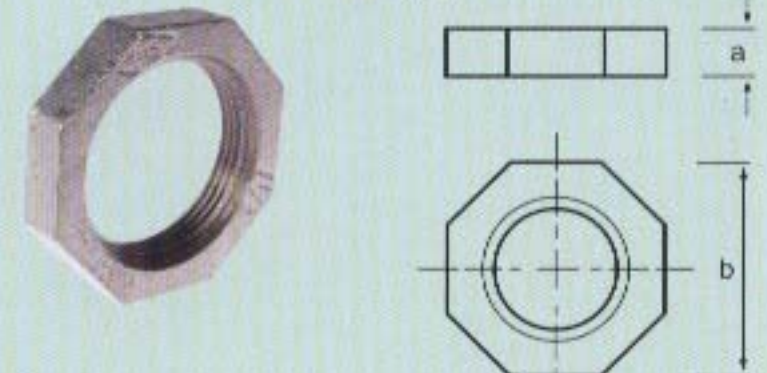
FIG. NO DESCRIPTION (ABBRE)	SIZE (INCH)	a	b (mm.)	c	PCS/ INNER	QTY OF INNER	PCS/ MASTER	WT/ MASTER KGS.
FIG. 312 (28) LOCKNUTS (LN) 	1/4	7.5	22.0					
	3/8	8.0	27.0		125	12	1,500	39
	1/2	8.0	32.0		100	12	1,200	45
	3/4	9.0	36.0		60	12	720	40
	1	10.0	46.0		40	12	480	41
	1-1/4	12.0	55.0		30	12	360	42
	1-1/2	12.0	60.0		45	6	270	42
	2	13.0	75.0		25	6	150	37
	2-1/2	17.0	99.7		28	3	84	40
	3	18.0	113.5		20	3	60	38
	4	22.0	145.0		14	2	28	33
	5	22.0	165.0		10	2	20	25
6	30.0	200.0		6	2	12	34	

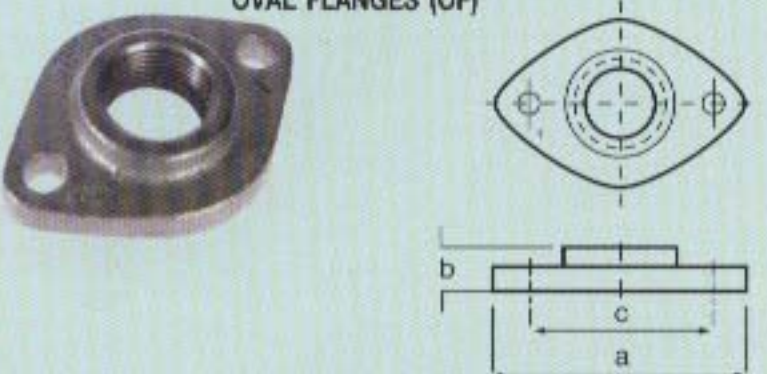
FIG. NO DESCRIPTION (ABBRE)	SIZE (INCH)	a	b (mm.)	c	PCS/ INNER	QTY OF INNER	PCS/ MASTER	WT/ MASTER KGS.
FIG. (320) OVAL FLANGES (OF) 	1/2	80.0	17.0	55.0	25	8	200	55
	1-1/4	120.0	22.0	90.0	15	6	90	50
	2	140.0	24.0	110.0	8	6	48	33
BRITISH STANDARD								

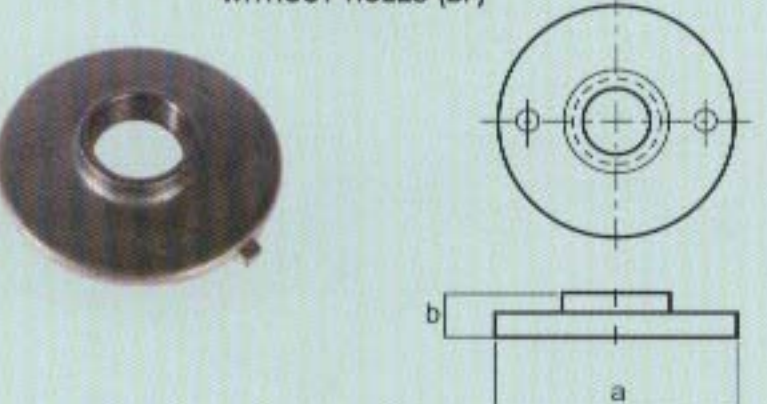
FIG. NO DESCRIPTION (ABBRE)	SIZE (INCH)	a	b (mm.)	c	PCS/ INNER	QTY OF INNER	PCS/ MASTER	WT/ MASTER KGS.
FIG. 321A (27) FLOOR FLANGES WITHOUT HOLES (BF) 	1/8	50.0	8.3					
	1/4	64.2	8.5		30	8	240	25
	3/8	75.0	10.0		25	8	200	28
	1/2	95.0	12.0		25	8	200	56
	3/4	102.0	14.0		20	8	160	46
	1	114.0	16.0		20	6	120	46
	1-1/4	120.0	18.0		15	6	90	34
	1-1/2	133.0	19.0		12	6	72	35
	2	152.0	21.0		8	6	48	33
	2-1/2	164.5	24.0		20	2	40	49
	3	184.0	26.0		5	6	30	52
	4	216.0	30.0				12	31
5	254.0	32.0				8	31	
6	280.0	35.0				8	38	
BRITISH STANDARD								

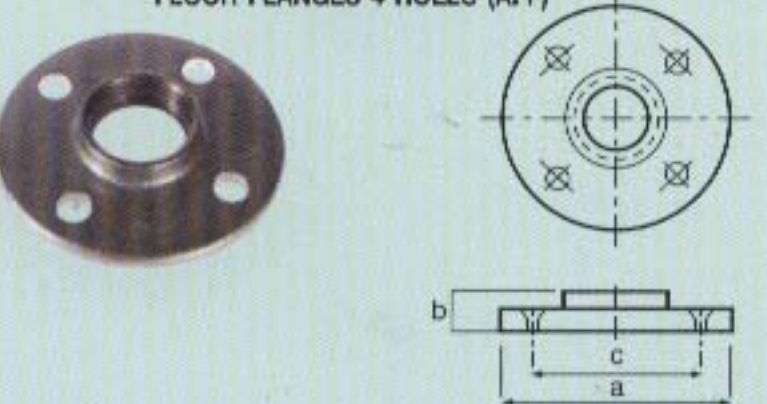
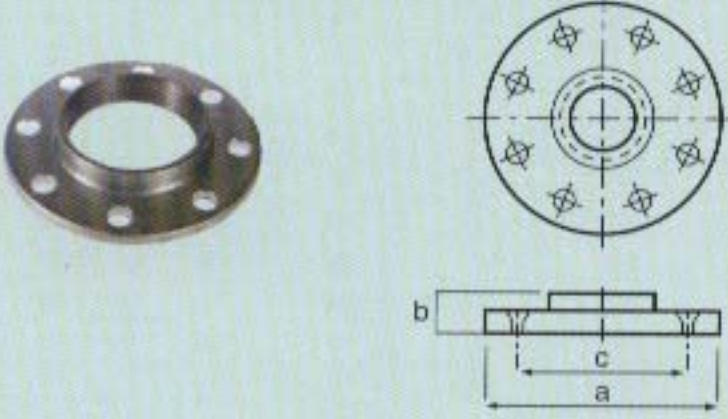
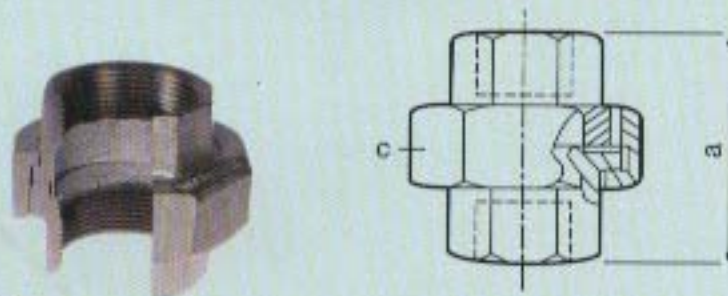
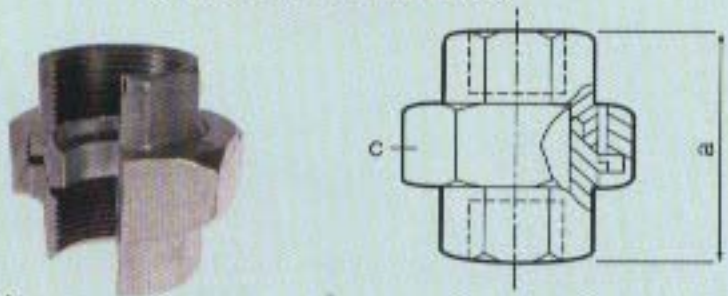
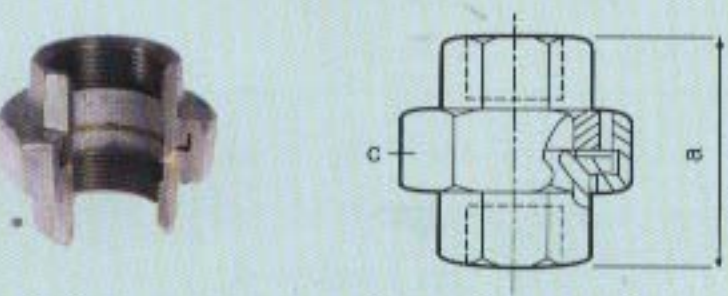
FIG. NO DESCRIPTION (ABBRE)	SIZE (INCH)	a	b (mm.)	c	PCS/ INNER	QTY OF INNER	PCS/ MASTER	WT/ MASTER KGS.
FIG. 321B (27) FLOOR FLANGES 4 HOLES (AFF) 	1/4	60.0	8.6	40.0	30	8	240	25
	3/8	68.0	12.0	46.0	25	8	200	28
	1/2	76.0	12.5	52.0	25	8	200	56
	3/4	82.5	14.0	58.0	20	8	160	46
	1	94.4	19.0	70.2	20	6	120	46
	1-1/4	101.4	19.0	76.7	15	6	90	34
	1-1/2	112.7	23.5	84.0	12	6	72	33
	2	129.3	25.3	100.0	8	6	42	33

FIG. NO DESCRIPTION (ABBRE)	SIZE (INCH)	a	b (mm.)	c	PCS/ INNER	QTY OF INNER	PCS/ MASTER	WT/ MASTER KGS.	
FIG. 321 C (27) FLOOR FLANGES (FD 4 HOLES 1/2-4", 8 HOLES 6") (FE 4 HOLES 1/2-3", 8 HOLES 4", 6")	1/2	95.5	12.0	67.0	25	8	200	56	
	3/4	102.0	14.0	73.0	20	8	160	46	
	1	114.0	16.0	82.0	20	6	120	46	
	1-1/4	120.0	18.0	87.0	15	6	90	34	
	1-1/2	133.0	19.0	98.0	12	6	72	35	
	2	152.0	21.0	114.0	8	6	48	33	
	2-1/2	165.0	24.0	127.0	20	2	40	49	
	3	184.0	26.0	146.0	5	6	30	52	
	4	216.0	30.0	178.0			12	31	
	5	254.0	32.0	209.0					
	6	280.0	35.0	235.0			8	38	
									
	BRITISH STANDARD								
	FIG. 330 (34A) UNION FLAT SEAT (U)	1/8	29.5		25.0	30	12	360	22
1/4		33.2		31.0	20	12	240	22	
3/8		38.0		37.0	20	12	240	36	
1/2		40.8		43.0	50	4	200	40	
3/4		49.0		50.0	35	4	140	41	
1		54.5		60.0	20	4	80	35	
1-1/4		60.5		70.5	15	4	60	43	
1-1/2		67.5		79.0	10	4	40	33	
2		75.5		94.5	6	4	24	30	
2-1/2		85.0		113.0	8	2	16	34	
3		93.5		128.0	7	2	14	39	
4		115.0		159.0			7	34	
6		139.0		219.0			4	39	
									
Note : C : Spanner width									
BRITISH STANDARD									
FIG. 340 (34C) UNION CONICAL JOINT IRON TO IRON FEMALE (EU)	3/8	44.0		36.0	20	12	240	39	
	1/2	48.0		41.0	50	4	200	33	
	3/4	52.0		50.0	35	4	140	39	
	1	58.0		55.0	20	4	80	27	
	1-1/4	66.0		70.0	15	4	60	37	
	1-1/2	69.0		75.0	10	4	40	29	
	2	78.0		90.0	6	4	24	28	
	2-1/2	84.0		110.0	8	2	16	30	
	3	95.0		130.0	7	2	14	39	
	4	110.0		150.0			7	26	
									
	Note : C : Spanner width								
	BRITISH STANDARD								
	FIG. 350 (34B) UNION BRASS SEAT (AU)	1/8	29.5		25.0	30	12	360	22
1/4		33.2		31.0	20	12	240	22	
3/8		38.0		37.0	20	12	240	36	
1/2		40.8		43.0	50	4	200	40	
3/4		49.0		50.0	35	4	140	41	
1		54.5		60.0	20	4	80	35	
1-1/4		60.5		70.5	15	4	60	43	
1-1/2		67.5		79.0	10	4	40	33	
2		75.5		94.5	6	4	24	30	
2-1/2		85.0		113.0	8	2	16	34	
3		93.5		128.0	7	2	14	39	
4		115.5		159.0			7	34	
6		139.0		219.0			4	39	
									



Packing List A6

Fig No.	Abbr.	Description	1/8"	1/4"	3/8"	1/2"	3/4"	1"	1-1/4"	1-1/2"	2"
1	BMF90	Bends M&F 90		450		180	90	45	20	15	8
2	BF90	Bends Female 90	240	220	200	150	80	40	20	14	7
3	BM90	Bends Male 90				270	100	70	30	20	12
40	BMF45	Bends M&F 45	320	300	400	200	110	70	30	25	14
41	BF45	Female 45	320	300	300	150	90	50	30	20	10
90	L90	Elbows 90	1,100	600	350	230	120	70	45	30	18
92	SL90	Street Elbows 90	1,200	700	500	230	130	70	40	30	15
120	L45	Elbows 45	900	630	400	250	150	90	45	30	20
121	SL45	Street Elbows 45	320	650	500	300	180	100	50	35	18
130	T	Tees	620	320	200	140	80	45	25	22	6
131	PT	Pitchers Tees				80	60	30	20	15	6
134	ST	Service Tees				150	80	45		21	12
180	CR	Crosses	500	280	170	110	60	40	18	17	7
221	SOL	Side Outlet Elbows	220	200	190	140	80	50	25	18	9
223	SOT	Side Outlet Tees					60	40	20	12	6
246	X	Extension Pieces			500	350	190	100	50	40	20
270	S	Sockets	1,200	800	500	300	180	110	60	40	24
280	NI	Hexagon Nipples		1,000	600	380	200	130	70	60	30
290	P	Plugs	5,000	3,000	1,600	1,000	500	300	150	120	70
301	CA	Caps	1,000	1,000	700	500	300	180	100	80	50
312	LN	Locknuts			1,500	900	600	370	200	150	100
320	OF	Oval Collar Flanges				200	120	108	50	40	40
321A	F	Floor Flanges without hole	450	320	250	150	70	60	40	30	20
321B	FD	Floor Flanges with 4 hole	450	270	200	150	70	60	40	30	20
321C	FE	Floor Flanges with 8 hole									
330	UF	Unions Flat seat	350	250	200	130	60	50	30	25	14
350	U	Unions Brass seat		350	200	130	60	50	30	25	14

Dimension in cm		L	W	H
Carton		31.4	22.9	18.6
Pallet		98	112	
Cartons/pallet		70		

Pressure / Temperature Rating

Service Temperature °C	Maximum permissible working pressure - bar
-20 to 120	25
between 120 and 300	interpolated values
300	20



Thread designation and nominal size

inch	1/8	1/4	3/8	1/2	3/4	1	1 1/4	1 1/2	2	2 1/2	3	4	5	6
mm.	6	8	10	15	20	25	32	40	50	65	80	100	125	150

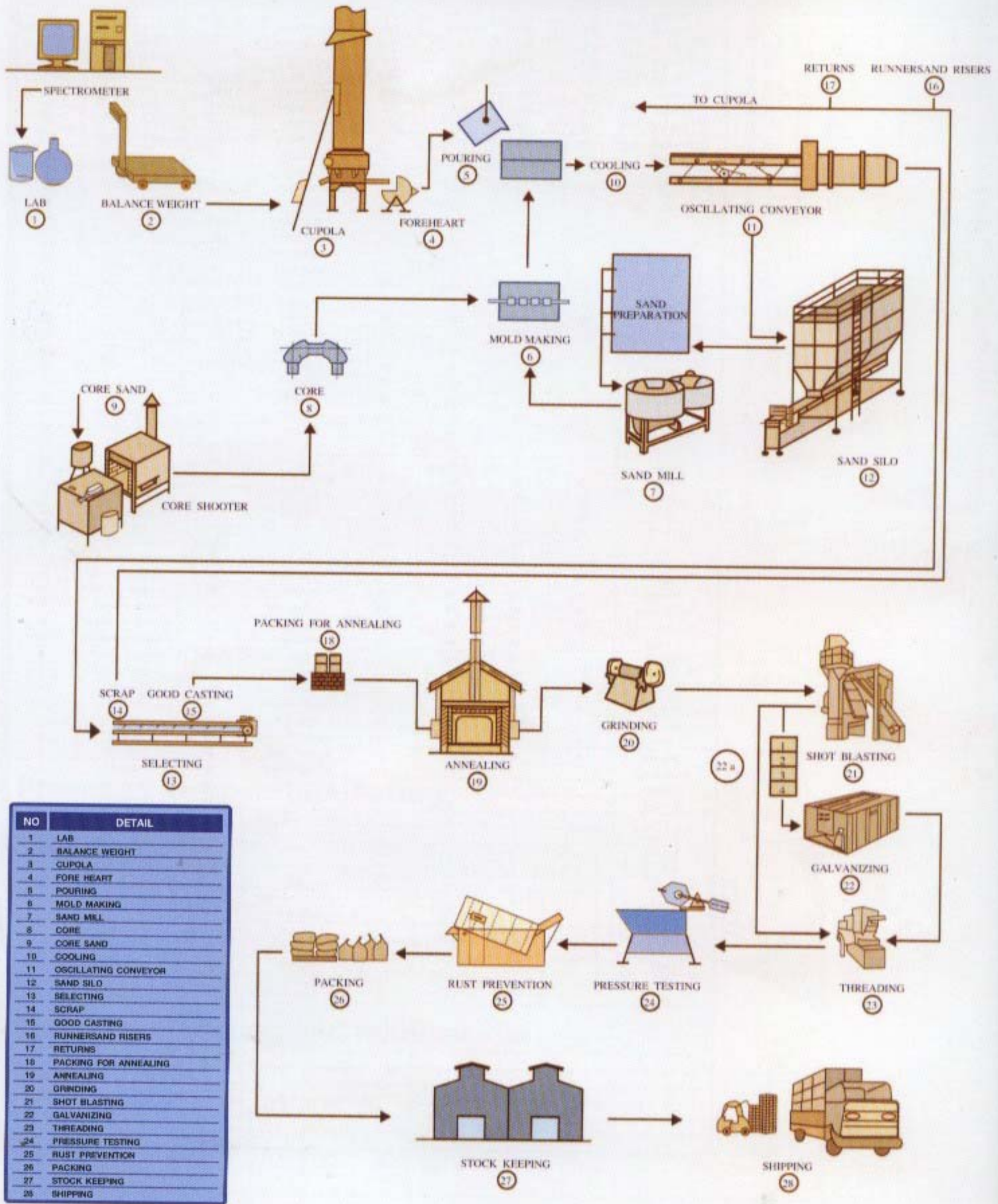


2-1/2"	3"	3-1/2"	4"	5"	6"
3			4		1
3	2		2		1
					1
6	3		2		1
6	3				1
10	4	3	2	1	1
8	5		2	1	1
10	6		2	2	1
12	6		2		
6	4	2	2	1	1
5	4		1		1
18	12		5	3	3
18	12		6	4	2
35	35	30	14	8	7
32	20		12	8	5
40	35		20		
15	15		6	3	2
15	12		6	3	2
			6	3	2
10	5		4	1	1
10	5		4	1	1

Abbr. Fig No.	RL 90R	RS 240	BU 241	RNI 245	Abbr. Fig No.	RT 130R	Abbr. Fig No.	RT 130R
1/4x1/8		1,000	1,200	750	1/4x1/4x1/8"	400	1-1/2x1-1/4x1-1/4"	20
3/8x1/8	450	500	1,000	700	3/8x3/8x1/8"	300	1-1/2x1-1/4x1-1/2"	20
3/8x1/4	450	500	1,000	700	3/8x3/8x1/4	300	1-1/2x1-1/4x2"	16
1/2x1/8	350	450	500	400	1/2x1/2x1/8"	200	1-1/2x1-1/2x1/4"	30
1/2x1/4	350	450	500	450	1/2x1/2x1/4"	150	1-1/2x1-1/2x1/2"	30
1/2x3/8	300	420	500	500	1/2x1/2x3/8"	150	1-1/2x1-1/2x3/4	30
3/4x1/8	130	200	350		1/2x1/2x3/4"	100	1-1/2x1-1/2x1"	30
3/4x1/4	170	200	350	250	1/2x1/2x1"	70	1-1/2x1-1/2x1-1/4"	25
3/4x3/8	170	200	350	230	3/4x3/8x3/4"	90	1-1/2x1-1/2x2"	16
3/4x1/2	150	200	350	230	3/4x1/2x1/2"	100	2x3/4x2"	22
1x1/8			250		3/4x1/2x3/4"	75	2x1x1/2"	20
1x1/4	110	160	250	180	3/4x1/2x1"	65	2x1x3/4"	20
1x3/8	120	150	250	150	3/4x3/4x1/8"	75	2x1x1"	20
1x1/2	100	120	250	150	3/4x3/4x1/4"	100	2x1x1-1/4"	16
1x3/4	100	110	250	150	3/4x3/4x3/8"	75	2x1x1-1/2"	16
1-1/4x1/8		80	130		3/4x3/4x1/2"	75	2x1x2"	16
1-1/4x1/4			130		3/4x3/4x1"	50	2x1-1/4x1/2"	25
1-1/4x3/8	50		130	100	1x1/2x1/2"	60	2x1-1/4x3/4"	25
1-1/4x1/2	55	70	130	90	1x1/2x3/4"	60	2x1-1/4x1"	20
1-1/4x3/4	55	70	130	80	1x1/2x1"	50	2x1-1/4x1-1/4"	15
1-1/4x1	50	70	130	80	1x3/4x1/2"	70	2x1-1/4x1-1/2"	15
1-1/2x1/4			90		1x3/4x3/4"	60	2x1-1/4x2"	16
1-1/2x3/8	50	60	150	60	1x3/4x1"	60	2x1-1/2x1/2"	16
1-1/2x1/2	50	60	120	60	1x1x1/4"	70	2x1-1/2x1"	16
1-1/2x3/4	45	60	120	60	1x1x3/8"	70	2x1-1/2x1-1/4"	16
1-1/2x1	35	50	120	60	1x1x1/2"	60	2x1-1/2x1-1/2"	16
1-1/2x1-1/4	30	40	120	60	1x1x3/4"	50	2x1-1/2x2"	15
2x1/4		36	90		1x1x1-1/4"	30	2x2x1/2"	24
2x3/8		35	90		1x1x1-1/2"	30	2x2x3/4"	22
2x1/2	25	36	50	36	1-1/4x1/2x1/2"	50	2x2x1"	16
2x3/4	25	36	50	36	1-1/4x1/2x3/4"	50	2x2x1-1/4"	16
2x1	25	36	50	36	1-1/4x1/2x1"	30	2x2x2-1/2"	15
2x1-1/4	20	30	50	35	1-1/4x1/2x1-1/4"	30	2x2x2-1/2"	9
2x1-1/2	20	24	50	35	1-1/4x3/4x1/2"	50	2-1/2x1-1/2x2-1/2"	6
2-1/2x1/2		20	40		1-1/4x3/4x3/4"	40	2-1/2x2x2-1/2"	6
2-1/2x3/4	15	20	40		1-1/4x3/4x1"	30	2-1/2x2-1/2x1/2"	10
2-1/2x1	15	20	40	24	1-1/4x3/4x1-1/4"	30	2-1/2x2-1/2x3/4"	10
2-1/2x1-1/4	12	20	40	24	1-1/4x1x1/2"	30	2-1/2x2-1/2x1"	10
2-1/2x1-1/2	12	16	40	24	1-1/4x1x3/4"	30	2-1/2x2-1/2x1-1/4"	10
2-1/2x2	10	16	40	24	1-1/4x1x1"	30	2-1/2x2-1/2x1-1/2"	10
3x1/2		16	18		1-1/4x1x1-1/4	25	2-1/2x2-1/2x2"	8
3x3/4		16	18		1-1/4x1-1/4x1/4"		2-1/2x2-1/2x3"	5
3x1		16	18	15	1-1/4x1-1/4x1/2"	40	2x1/2x1/2"	30
3x1-1/4	6	10	18	15	1-1/4x1-1/4x3/4"	40	2x1/2x2"	24
3x1-1/2	6	10	18	15	1-1/4x1-1/4x1"	30	3x2x2"	5
3x2	6	10	18	15	1-1/4x1-1/4x1+1/2"	16	3x3x1/2"	6
3x2-1/2	5	9	18	12	1-1/4x1-1/4x2"	16	3x3x3/4"	6
3-1/2x1-1/2			20		1-1/2x1/2x1/2"	35	3x3x1"	6
3-1/2x2			20		1-1/2x1/2x3/4"	35	3x3x1-1/4"	6
3-1/2x3			20		1-1/2x1/2x1"	35	3x3x1-1/2"	6
4x1		7	10		1-1/2x1/2x1-1/4"	25	3x3x2"	5
4x1-1/4		7	10		1-1/2x1/2x1-1/2"	25	3x3x2-1/2"	5
4x1-1/2		6	10	7	1-1/2x3/4x1/2"	40	4x4x1/2"	3
4x2-1/2	3	6	10	8	1-1/2x3/4x3/4"	40	4x4x3/4"	2
4x3	3	6	10	8	1-1/2x3/4x1"	40	4x4x1"	2
5x3		6			1-1/2x3/4x1-1/4"	25	4x4x1-1/4	2
5x4		4	6		1-1/2x3/4x1-1/2"	30	4x4x1-1/2"	2
6x2		4	5		1-1/2x1x1/2"	40	4x4x2"	2
6x2-1/2		3			1-1/2x1x3/4"	30	4x4x2-1/2"	2
6x3		4	5		1-1/2x1x1"	30	4x4x3"	2
6x4		4	5	5	1-1/2x1x1-1/4"	20	5x5x3"	2
6x5		2	5		1-1/2x1x1-1/2"	20	6x6x2"	1
					1-1/2x1-1/4x1/2"	30	6x6x2-1/2"	1
					1-1/2x1-1/4x3/4"	30	6x6x3"	1
					1-1/2x1-1/4x1"	25	6x6x4"	1



BIS PIPE FITTING INDUSTRY PROCESS CHART FOR BLACKHEART MALLEABLE FITTINGS



NO	DETAIL
1	LAB
2	BALANCE WEIGHT
3	CUPOLA
4	FORE HEART
5	POURING
6	MOLD MAKING
7	SAND MILL
8	CORE
9	CORE SAND
10	COOLING
11	OSCILLATING CONVEYOR
12	SAND SILO
13	SELECTING
14	SCRAP
15	GOOD CASTING
16	RUNNERSAND RISERS
17	RETURNS
18	PACKING FOR ANNEALING
19	ANNEALING
20	GRINDING
21	SHOT BLASTING
22	GALVANIZING
23	THREADING
24	PRESSURE TESTING
25	RUST PREVENTION
26	PACKING
27	STOCK KEEPING
28	SHIPPING

BRITISH STANDARD THREADS

British Engineering Standard Association Reports No. BS 21-1985

Forms of British Standard Pipe Threads

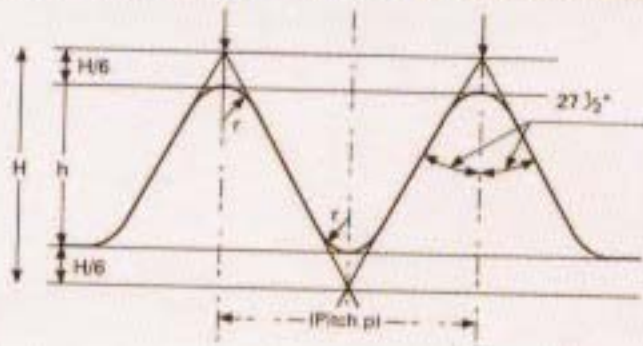


Fig. 1. (Parallel)
 $H = 0.960491 \times p$
 $h = 0.640327 \times p$
 $r = 0.137329 \times p$

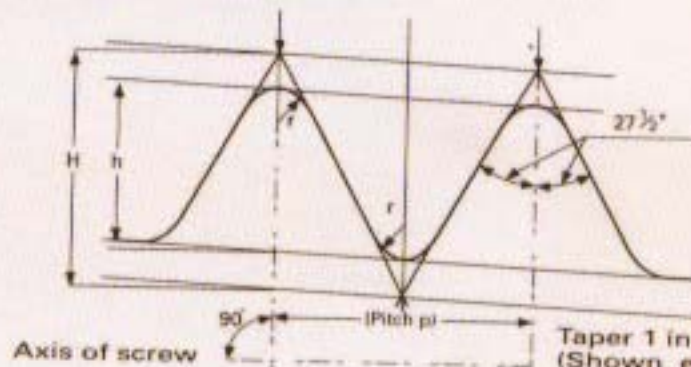


Fig. 2. (Taper)
 $H = 0.960237 \times p$
 $h = 0.640327 \times p$
 $r = 0.137278 \times p$

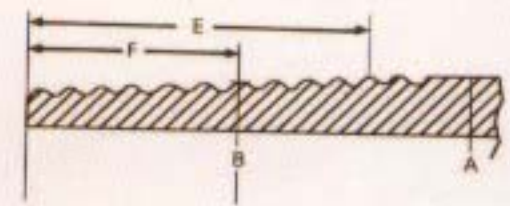


Fig. 3. (Taper)

Table 1. Basic Sizes

Nominal Bore of Pipe	Approximate Outside Diameter of Black Pipe	Number of Threads per Inch	Pitch	Depth of Thread	Diameter at Gauge Plane (Gauge Dia.)	Distance of Gauge Diameter from End (Gauge Length)	Dimensions, in Inch
							Length of Useful Thread
	A		P	h	B	F	E
1/8	0.400	28	0.03571	0.0229	0.383	0.1563	0.2545
1/4	0.538	19	0.05263	0.0337	0.518	0.2367	0.3814
3/8	0.676	19	0.05263	0.0337	0.656	0.2500	0.3947
1/2	0.847	14	0.07143	0.0457	0.825	0.3214	0.5178
3/4	1.063	14	0.07143	0.0457	1.041	0.3750	0.5714
1	1.336	11	0.09091	0.0582	1.309	0.4091	0.6591
1 1/4	1.677	11	0.09091	0.0582	1.650	0.5000	0.7500
1 1/2	1.909	11	0.09091	0.0582	1.882	0.5000	0.7500
2	2.381	11	0.09091	0.0582	2.347	0.6250	0.9204
2 1/2	2.996	11	0.09091	0.0582	2.960	0.6875	1.0511
3	3.499	11	0.09091	0.0582	3.460	0.8125	1.1761
3 1/2	3.991	11	0.09091	0.0582	3.950	0.8750	1.2386
4	4.494	11	0.09091	0.0582	4.450	1.0000	1.4091
5	5.498	11	0.09091	0.0582	5.450	1.1250	1.5795
6	6.501	11	0.09091	0.0582	6.450	1.1250	1.5795

AMERICAN STANDARD THREADS

Approved by American Standard Association ANSI B1.20.1-1983

Forms of American Standard Pipe Threads

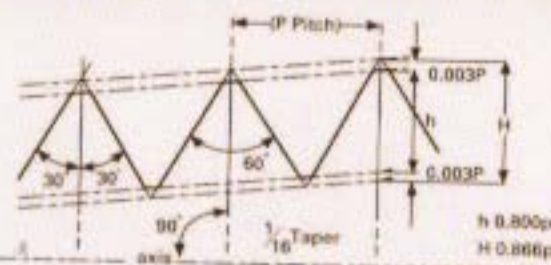


Fig. 4. (Taper)*
 $H = 0.8660 \times p$
 $h = 0.8000 \times p$

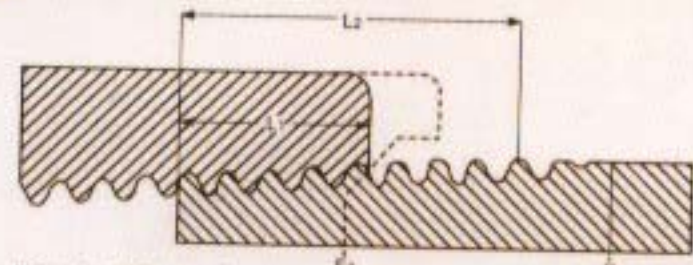


Fig. 5. (Taper)
 $L_2 = (0.8D + 6.8) \times 1/16$

*Straight Pipe Threads; the pitch, angle, and depth of thread are the same as the corresponding dimensions of the taper pipe threads

Table 2. Basic Dimensions

Nominal Pipe Size	Outside Diameter of Pipe	Threads per Inch	Pitch of Threads	Hand-Tight Engagement		Effective Thread Length External	Dimensions, in Inch
				L ₁	E ₁		Depth of Thread
	D	n	P	L ₁	E ₁	L ₂	h
1/8	0.405	27	0.03704	0.180	0.37476	0.2639	0.02963
1/4	0.540	18	0.05556	0.200	0.48989	0.4018	0.04444
3/8	0.675	18	0.05556	0.240	0.62701	0.4078	0.04444
1/2	0.840	14	0.07143	0.320	0.77843	0.5337	0.05714
3/4	1.050	14	0.07143	0.339	0.98887	0.5457	0.05714
1	1.315	11 1/2	0.08696	0.400	1.23863	0.6828	0.06957
1 1/4	1.660	11 1/2	0.08696	0.420	1.58338	0.7068	0.06957
1 1/2	1.900	11 1/2	0.08696	0.420	1.82234	0.7235	0.06957
2	2.375	11 1/2	0.08696	0.436	2.29627	0.7565	0.06957
2 1/2	2.875	8	0.12500	0.682	2.76216	1.1375	0.10000
3	3.500	8	0.12500	0.766	3.38850	1.2000	0.10000
3 1/2	4.000	8	0.12500	0.821	3.88981	1.2500	0.10000
4	4.500	8	0.12500	0.844	4.38712	1.3000	0.10000
5	5.563	8	0.12500	0.937	5.44929	1.4063	0.10000
6	6.625	8	0.12500	0.958	6.50597	1.5125	0.10000